

BELDEN



Quality
Precision
Reliability

Precisely what you need, Precisely when you need it

Regarding quality...

"extremely pleased with Belden's products...
Belden offers the best product for the least cost."

Regarding capabilities...

"We had a problem with the boots on the universal joint assemblies from our previous supplier. Belden engineers came here to meet with our engineers to resolve the problem and redesign the parts. The boot redesign was included on our assemblies within days. We have had no problems since."

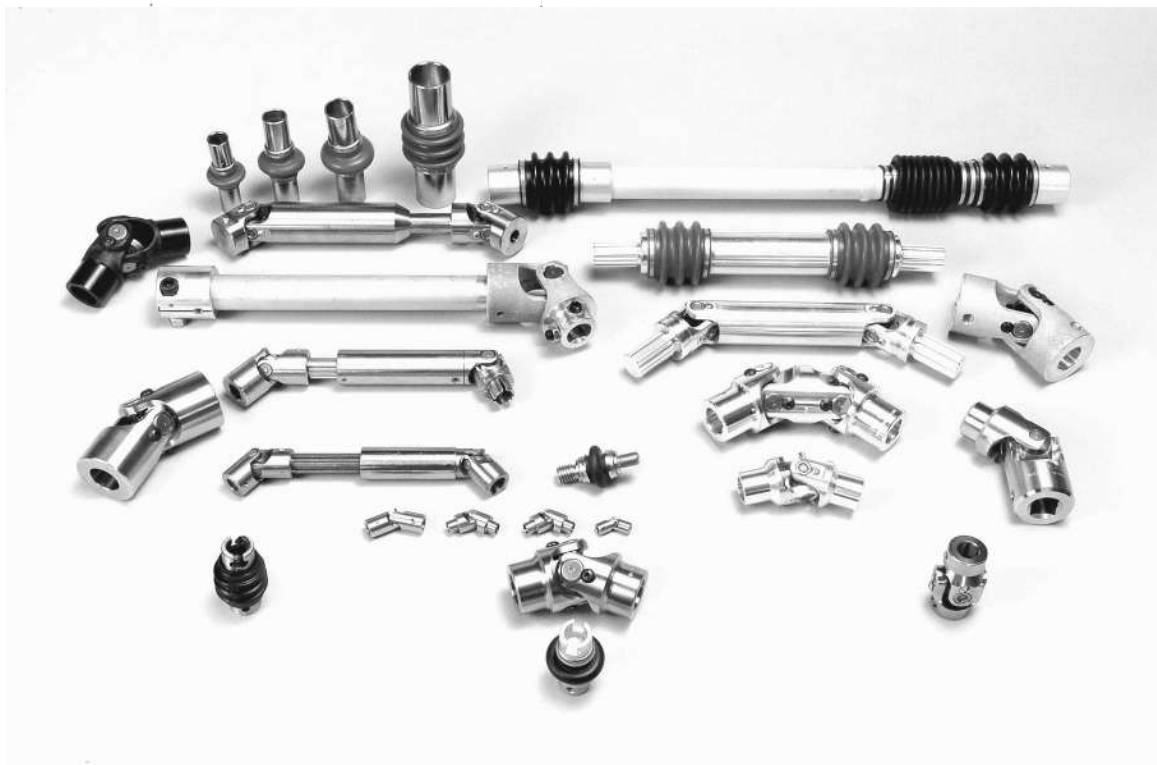

Regarding delivery.....

"the delivery time has been reduced since I first started doing business with Belden. Belden prepared themselves by stocking many of our frequently ordered parts."

Regarding delivery.....

"Belden cut their delivery in half by planning for our orders and stocking components in anticipation of our next release."

Regarding capabilities...

"We now buy other components from Belden. A Belden Sales Rep came to our facilities to look at how we were operating our equipment. She took part samples back to your [Belden's] engineering department. They suggested some changes and offered to make the parts for less than we were getting them before. We're getting a superior assembly that's cost effective."



Table of Contents

Introduction		4
Universal Joint Introduction		5
Single Universal Joints	(Inch Sizes)	6
Double Universal Joints	(Inch Sizes)	7
Stainless Steel Universal Joints	(Inch Sizes)	8
Needle Bearing Universal Joints	(Inch Sizes)	9
Drive Shafts / Custom Universal Joints	(Inch Sizes)	10
Military Standard Universal Joints	(Inch Sizes)	11
Forged Products		13
Aluminum Joints + Assemblies		14
Universal Joint Boot Covers	(Inch Sizes)	15
Standard Universal Joints	(Metric Sizes)	16
Precision Universal Joints	(Metric Sizes)	17
Stainless Steel Universal Joints	(Metric Sizes)	18
Needle Bearing Universal Joints	(Metric Sizes)	19
Quick Release Ends / Custom Drive Shafts & Universal Joints	(Metric Sizes)	20
Universal Joint Boot Covers	(Metric Sizes)	21
Request for Quotation for Universal Joints		22
Terminology		23
Contacting Belden		Back



Quality

For more than 30 years, Belden has supplied the world with the highest quality power transmission products. All Belden products are accurately manufactured to the highest standards set by the industry. Belden practices Total Quality Management to assure quality throughout the manufacturing process and to ensure that the end product meets and exceeds our customer's expectations.

Precision

Through innovated manufacturing processes, team-approach engineering and constant communication with our customers, Belden manufactures solutions. With this complete approach to manufacturing, customers only receive products meeting their exact specifications.

Reliability

Belden's growth in the power transmission world-market is due to the commitment of our long time customers and to the foresight of our new customers. All rely on the products they receive from Belden - not only are the products of the highest quality, but they are supplied at the lowest price possible while supported by the excellence of Belden's customer service.

Capabilities

Belden has far reaching capabilities beyond the superior products of our standard line. Belden is a forward thinking company committed to bringing the newest innovations in our field to our customers. We are goal driven, solution based and we constantly strive for customer satisfaction. For every customer challenge, Belden has a solution.

Belden universal joints satisfy a broad spectrum of system design requirements and should be considered when engineers are faced with the complicated challenges of today's manufacturing demands.

The Belden universal joint has become recognized as the most precise and reliable universal joint on the worldwide market today. Belden's team of professional design engineers is able to create and manufacture universal joints to fill almost any and every application, including:

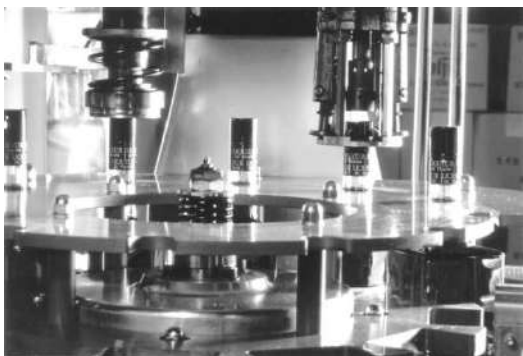

- > Medical Equipment
- > Metalworking Machinery
- > Military Applications
- > Printing Processes
- > Packaging Systems
- > Bottle Capping Systems
- > Conveying Systems
- > Steering Applications
- > Shift Linkage Applications
- > Woodworking Machinery
- > Agricultural Machinery
- > Drilling and Tapping Machinery
- > Machine Tool Applications
- > Aerospace Applications



Single Universal Joints

- High grade-alloy steel
- Standard operating angles up to 35°
- Wide choice of hub configurations and finishes

The Belden single pin & block universal joint is manufactured from high-grade alloy steel for increased durability and better performance than standard industrial-grade models. All components are heat treated, precision machined and ground to close tolerances. The Heavy Duty, High Strength or Leveler Strength universal joint provides exceptional service life in the most demanding applications. All joints are available with or without a lubricant retaining boot.

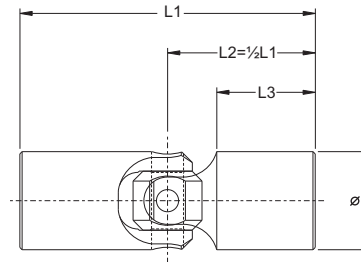

Heavy Duty Joints standard operating angle 35°, higher operational angles available upon request

Part No.	Nominal Size	ØD in [mm]	L1 in [mm]	L3 in [mm]	Ultimate Torque lbf-in [Nm]	Max. Operating Torque lbf-in [Nm]
UJ-HD375	3/8"	0.370 [9.39]	1.75 [44.5]	0.68 [17.2]	100 [11.3]	20 [2.3]
UJ-HD500	1/2"	0.495 [12.57]	2.00 [50.8]	0.75 [19.1]	350 [39.5]	70 [7.9]
UJ-HD625	5/8"	0.620 [15.75]	2.25 [57.2]	0.81 [20.6]	675 [76.3]	135 [15.2]
UJ-HD750	3/4"	0.745 [18.93]	2.69 [68.3]	0.95 [24.1]	1250 [141.1]	250 [28.2]
UJ-HD875	7/8"	0.870 [22.10]	3.00 [76.2]	1.03 [26.2]	1750 [197.7]	350 [39.5]
UJ-HD1000	1"	0.995 [25.27]	3.38 [85.7]	1.19 [30.2]	2250 [254.2]	450 [50.8]
UJ-HD1125	1-1/8"	1.120 [28.45]	3.50 [88.9]	1.22 [31.0]	3250 [366.9]	650 [73.4]
UJ-HD1250	1-1/4"	1.245 [31.62]	3.75 [95.3]	1.25 [31.8]	5200 [587.1]	1044 [117.9]
UJ-HD1500	1-1/2"	1.495 [37.97]	4.25 [108.0]	1.41 [35.7]	10000 [1129.8]	2000 [225.9]
UJ-HD1750	1-3/4"	1.745 [44.32]	5.00 [127.0]	1.60 [40.6]	14500 [1637.0]	2900 [327.4]
UJ-HD2000	2"	1.995 [50.67]	5.50 [139.7]	1.70 [43.2]	21500 [2429.2]	4300 [485.5]

High Strength Joints standard operating angle 35°, higher operational angles available upon request

UJ-HS500	1/2"	0.495 [12.57]	2.00 [50.8]	0.75 [19.1]	475 [53.7]	95 [10.7]
UJ-HS625	5/8"	0.620 [15.75]	2.25 [57.2]	0.81 [20.6]	950 [107.3]	190 [21.5]
UJ-HS750	3/4"	0.745 [18.93]	2.69 [68.3]	0.95 [24.1]	1750 [197.7]	350 [39.5]
UJ-HS875	7/8"	0.870 [22.10]	3.00 [76.2]	1.03 [26.2]	2500 [282.4]	500 [56.5]
UJ-HS1000	1"	0.995 [25.27]	3.38 [85.7]	1.19 [30.2]	4500 [508.4]	900 [101.7]
UJ-HS1125	1-1/8"	1.120 [28.45]	3.50 [88.9]	1.22 [31.0]	5500 [621.5]	1100 [124.3]
UJ-HS1250	1-1/4"	1.245 [31.62]	3.75 [95.3]	1.25 [31.8]	6800 [768.2]	1360 [153.7]
UJ-HS1500	1-1/2"	1.495 [37.97]	5.25 [133.4]	1.91 [48.4]	12500 [1412.1]	2500 [282.5]
UJ-HS1750	1-3/4"	1.745 [44.32]	6.25 [158.8]	2.23 [56.8]	16000 [1807.8]	3200 [361.6]
UJ-HS2000	2"	1.995 [50.67]	6.00 [152.4]	1.94 [49.2]	26000 [2937.6]	5200 [587.5]
UJ-HS2500	2-1/2"	2.495 [63.37]	8.50 [215.9]	2.81 [40.6]	32000 [3615.5]	6400 [723.1]
UJ-HS3000	3"	2.995 [76.07]	9.25 [235.0]	3.00 [76.2]	55000 [6214.2]	11000 [1242.8]

Leveler Style Joints standard operating angle 35°, unless noted*

UJ-LV1500	1-1/2"	1.495 [37.97]	5.25 [133.4]	1.91 [48.4]	15000 [1694.8]	3000 [339.0]
UJ-LV1750	1-3/4"	1.745 [44.32]	6.25 [158.8]	2.23 [56.8]	17500 [1974.9]	3500 [395.5]
UJ-LV2000	2"	1.995 [50.67]	5.50 [139.7]	1.72 [43.7]	28000 [3163.6]	5600 [632.7]
UJ-LV2500*	2-1/2"	2.495 [63.37]	8.50 [215.9]	3.00 [76.2]	50000 [5649.3]	10000 [1129.9]
UJ-LV3000*	3"	2.995 [76.07]	9.25 [235.0]	3.00 [76.2]	70000 [7909.0]	14000 [1581.8]
UJ-LV3500*	3-1/2"	3.495 [88.77]	10.50 [266.7]	3.50 [88.9]	100000 [11298.5]	20000 [2259.7]
UJ-LV4000*	4"	3.995 [101.47]	10.63 [269.9]	3.19 [81.0]	140000 [15817.9]	28000 [3163.6]

*Maximum operating angle 25°

Double Universal Joints

- High-grade alloy steel
- Standard operating angles up to 70°
- Uniform speed ratio between driving and driven shafts (with parallel output shafts)

The Belden double universal joint provides the same reliability and service life as the single universal joint with a maximum combined working angle of 70°. Double universal joints provide accurate positioning and flexibility under higher operating angles. Belden double universal joints are available in a wide variety of materials and finishes. Lubricant retaining boots are recommended for operation in corrosive environments.



Double Universal Joint

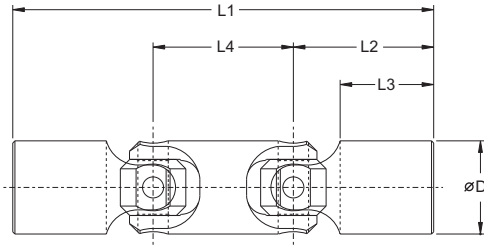

Butted Double Universal Joint

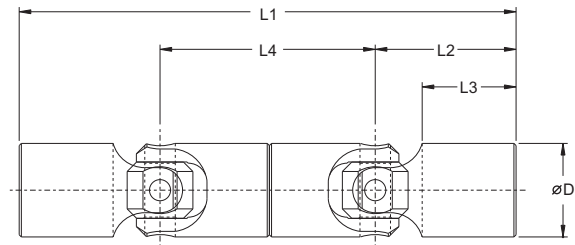

Double Universal Joints standard operating angle 70°, higher operational angles available upon request

Part No.	Nominal Size	ØD in [mm]	L1 in [mm]	L2 in [mm]	L3 in [mm]	L4 in [mm]	Max. Operating Torque lbf-in [Nm]
DUJ-HD625	5/8"	0.620 [15.75]	3.25 [82.6]	1.13 [28.6]	0.81 [20.6]	1.00 [25.4]	122 [13.7]
DUJ-HD750	3/4"	0.745 [18.93]	3.81 [96.8]	1.34 [34.1]	0.95 [24.1]	1.13 [28.6]	225 [25.4]
DUJ-HD875	7/8"	0.870 [22.10]	4.38 [111.1]	1.25 [38.1]	1.03 [26.2]	1.38 [35.0]	315 [35.6]
DUJ-HD1000	1"	0.995 [25.27]	4.88 [123.8]	1.69 [42.9]	1.19 [30.2]	1.50 [38.1]	405 [45.8]
DUJ-HD1125	1-1/8"	1.120 [28.45]	5.13 [130.2]	1.75 [44.4]	1.22 [31.0]	1.63 [41.3]	585 [66.1]
DUJ-HD1250	1-1/4"	1.245 [31.62]	5.63 [142.9]	1.88 [47.6]	1.25 [31.8]	1.88 [47.6]	940 [106.2]
DUJ-HD1500	1-1/2"	1.495 [37.97]	6.56 [166.7]	2.13 [54.0]	1.41 [35.7]	2.31 [58.7]	1800 [203.4]
DUJ-HD1750	1-3/4"	1.745 [44.32]	7.75 [196.9]	2.50 [63.5]	1.60 [40.6]	2.75 [69.9]	2610 [294.9]
DUJ-HD2000	2"	1.995 [50.67]	8.69 [220.7]	2.75 [69.9]	1.70 [43.2]	3.19 [81.0]	3870 [437.3]

Butted Double Universal Joints standard operating angle 70°, higher operational angles available upon request

UJ-DD375	3/8"	0.370 [9.39]	3.50 [88.9]	0.88 [22.2]	0.68 [17.2]	1.75 [44.5]	18 [2.0]
UJ-DD500	1/2"	0.495 [12.57]	4.00 [101.6]	1.00 [25.4]	0.75 [19.1]	2.00 [50.5]	63 [7.1]
UJ-DD625	5/8"	0.620 [15.75]	4.50 [114.3]	1.13 [28.6]	0.81 [20.6]	2.25 [57.2]	122 [13.7]
UJ-DD750	3/4"	0.745 [18.93]	5.38 [136.5]	1.34 [34.1]	0.95 [24.1]	2.69 [68.3]	225 [25.4]
UJ-DD875	7/8"	0.870 [22.10]	6.00 [152.4]	1.50 [38.1]	1.03 [26.2]	3.00 [76.2]	315 [35.6]
UJ-DD1000	1"	0.995 [25.27]	6.75 [171.5]	1.69 [42.9]	1.19 [30.2]	3.38 [85.7]	405 [45.8]
UJ-DD1125	1-1/8"	1.120 [28.45]	7.00 [177.8]	1.75 [44.5]	1.22 [31.0]	3.50 [88.9]	585 [66.1]
UJ-DD1250	1-1/4"	1.245 [31.62]	7.50 [190.5]	1.88 [47.6]	1.25 [31.8]	3.75 [95.3]	940 [106.2]
UJ-DD1500	1-1/2"	1.495 [37.97]	8.50 [215.9]	2.13 [54.0]	1.41 [35.7]	4.25 [108.0]	1800 [203.4]
UJ-DD1750	1-3/4"	1.745 [44.32]	10.00 [254.0]	2.50 [63.5]	1.60 [40.6]	5.00 [127.0]	2610 [294.9]
UJ-DD2000	2"	1.995 [50.67]	11.00 [279.4]	2.75 [69.9]	1.70 [43.2]	5.50 [139.7]	3870 [437.3]

Stainless Steel Universal Joints

- Corrosion resistant
- Standard operating angles up to 35°
- Can be booted for further environmental protection

The standard stainless steel joint is made from AISI 303 and AISI 416 stainless steel. The joint yokes are 303 and the pins & blocks are hardened 416 stainless steel to provide higher strength and improved wear resistance. Yokes can be made from 303, 304, 316L, 416 and 420 stainless steel to meet the customer's exact application specifications. For additional environmental protection, pins & blocks can be covered by lubricant retaining boots or manufactured from higher grades of stainless steel.

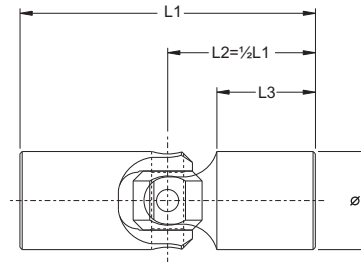

Stainless Steel Universal Joints standard operating angle 35°, higher operational angles available upon request

Part No.	Nominal Size	Ø D in [mm]	L1 in [mm]	L3 in [mm]	Ultimate Torque lbf-in [Nm]	Max. Operating Torque lbf-in [Nm]
UJ-SS500	1/2"	0.495 [12.57]	2.00 [50.8]	0.75 [19.1]	240 [27.1]	48 [5.4]
UJ-SS625	5/8"	0.620 [15.75]	2.25 [57.2]	0.81 [20.6]	475 [53.7]	95 [10.7]
UJ-SS750	3/4"	0.745 [18.93]	2.69 [68.3]	0.95 [24.1]	875 [98.9]	175 [19.8]
UJ-SS875	7/8"	0.870 [22.10]	3.00 [76.2]	1.03 [26.2]	1260 [142.4]	250 [28.3]
UJ-SS1000	1"	0.995 [25.27]	3.38 [85.7]	1.19 [30.2]	1575 [178.0]	315 [35.6]
UJ-SS1125	1-1/8"	1.120 [28.45]	3.50 [88.9]	1.22 [31.0]	2250 [254.2]	450 [50.8]
UJ-SS1250	1-1/4"	1.245 [31.62]	3.75 [95.3]	1.25 [31.8]	3400 [384.2]	680 [76.8]
UJ-SS1500	1-1/2"	1.495 [37.97]	4.25 [108.0]	1.41 [35.7]	7250 [819.1]	1450 [163.8]
UJ-SS1750	1-3/4"	1.745 [44.32]	5.00 [127.0]	1.60 [40.6]	10500 [1186.3]	2100 [237.3]
UJ-SS2000	2"	1.995 [50.67]	5.50 [139.7]	1.70 [43.2]	15600 [1762.6]	3120 [352.5]

The yokes of our standard stainless steel joints are made from 303 (AISI) /1.4305 (DIN) steel. Pins and blocks are made from 416 (AISI) /1.4005 (DIN) steel. Various grades of Stainless Steel are available upon request.

Performance Curve for Pin + Block Universal Joint

The chart is a guideline. Please consult Belden with your specific application.

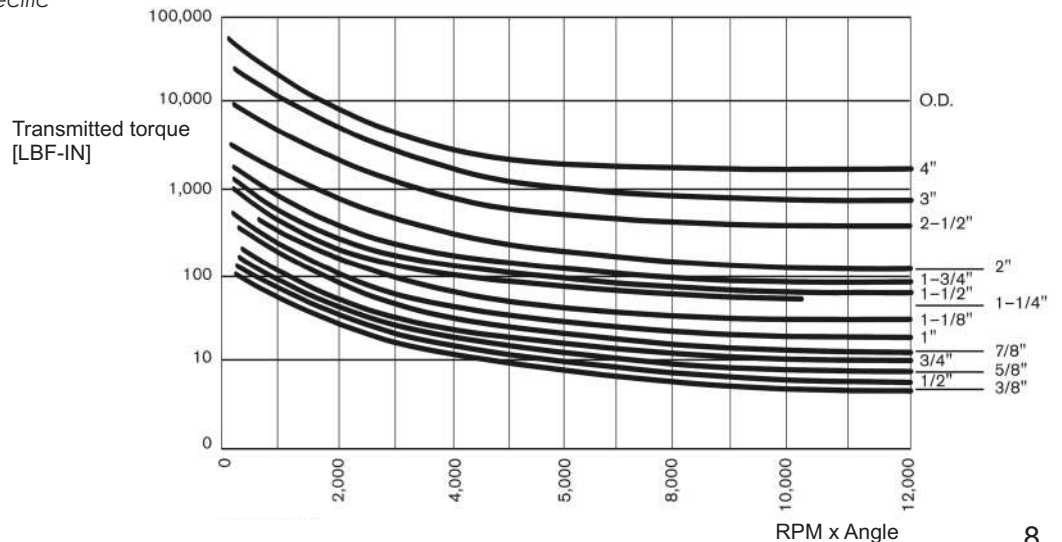

Needle Bearing Universal Joints

- Operation at high RPM
- Low backlash
- Continuous operation

The needle bearing universal joint is fitted with pre-lubricated needle bearings. Needle bearing universal joints are designed to maintain low backlash for critical positioning applications required by robotics and instrumentation and are excellent for continuous operation applications. The joint has rigid axial stiffness for push/pull loads and can handle higher angles and RPM.

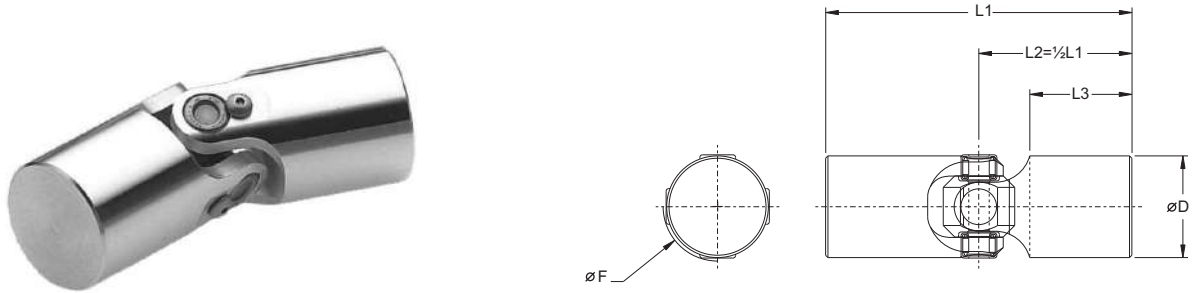

Needle Bearing Joints standard operating angle 35°, higher operational angles available upon request

Part No.	Nominal Size	ø D in [mm]	L1 in [mm]	L3 in [mm]	F in [mm]
UJ-NB750	3/4"	0.745 [18.93]	2.69 [68.3]	0.95 [24.1]	0.97 [24.6]
UJ-NB1000	1"	0.995 [25.27]	3.38 [85.7]	1.19 [30.2]	1.05 [26.6]
UJ-NB1250	1-1/4"	1.245 [31.62]	3.75 [95.3]	1.25 [31.8]	1.38 [34.9]
UJ-NB1500	1-1/2"	1.495 [37.97]	4.25 [108.0]	1.41 [35.7]	1.63 [41.4]
UJ-NB40	1.58"	1.580 [40.00]	5.50 [139.7]	2.00 [50.8]	1.78 [45.2]
UJ-NB2000	2"	1.995 [50.67]	5.50 [139.7]	1.69 [42.9]	2.25 [57.2]
UJ-NB2500	2-1/2"	2.495 [63.37]	8.50 [215.9]	3.00 [76.2]	2.50 [63.5]

Performance Curve for Needle Bearing Universal Joints

This chart is a guideline. Please consult Belden for your specific application.

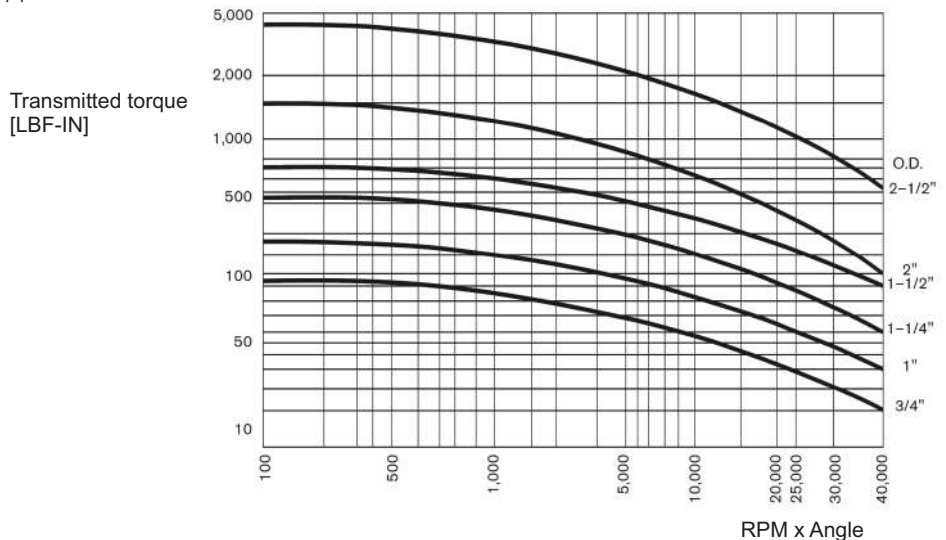

Custom Universal Joints and Drive Shafts

- Uniform speed ratio between driving and driven shafts
- Quick-change feature available
- Custom designed to meet customer specifications

Belden design engineers can specify a universal joint assembly to meet the most unique requirements. In addition to the high-quality alloy steel standard of Belden universal joints, assemblies can be manufactured from a variety of materials, including various grades of stainless steel. Belden's capabilities allow us to provide precise, reliable and durable universal joints for customers' exact application specifications.



Quick/Change Feature

A quick-change feature is available on our custom universal joint drive shaft assembly which allows the universal joint to be quickly removed and replaced without tools. This is an essential feature when machine downtime is crucial. The quick-change universal joint consists of two back-to-back single universal joints connected with a spring loaded intermediate shaft. Pinning of outer yokes is not required because the spring tension on the intermediate shaft holds the quick-change universal joint secure at each end.

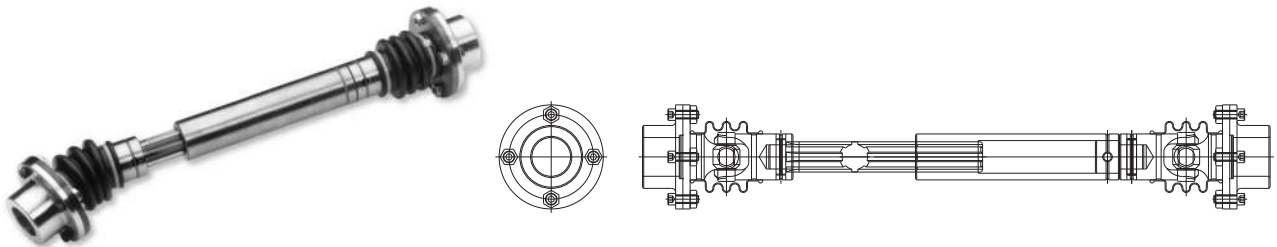

End Hub Configurations

Belden offers a wide variety of end hub configurations. The six most conventional hub types, in either male or female, are available in metric or inch sizes. Solid hubs are also available. Custom universal joints and drive shaft assemblies are our specialty.

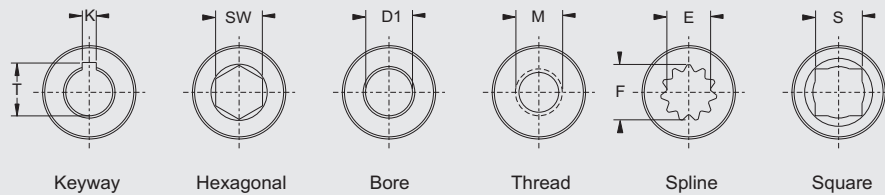

Military Standard Joint - MS20270 Light Duty Series

- Meets or exceeds military specification MIL-J-6193

Belden military standard universal joints are precisely designed and manufactured for a variety of applications. These include specifications where low deflection rates, high strength-to-weight ratios and long service life are essential.

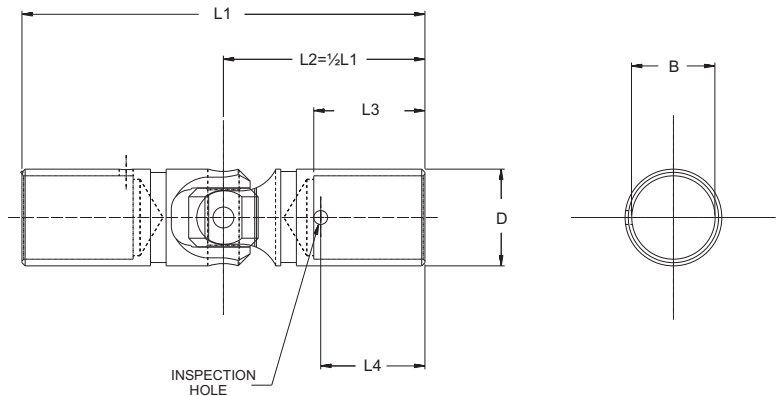

MS20270 Series

Part No.	Nominal Size	∅ D +0.000 [+0.00] - 0.002 [- 0.05] in [mm]	L1 Overall Length in [mm]	L3 in [mm]	∅B +0.004 [+0.10] - 0.001 [- 0.03] in [mm]	L4 Inspection Hole Location in [mm]	Weight Maximum lb [kg]
MS20270B6	3/8"	0.372 [9.45]	1.750 [44.45]	0.375 [9.53]	0.250 [6.35]	0.312 [7.92]	0.035 [0.02]
MS20270B8	1/2"	0.495 [12.57]	1.875 [47.63]	0.500 [12.70]	0.375 [9.53]	0.437 [11.10]	0.065 [0.03]
MS20270B10	5/8"	0.620 [15.75]	2.187 [55.55]	0.625 [15.88]	0.500 [12.70]	0.562 [14.27]	0.095 [0.04]
MS20270B12	3/4"	0.745 [18.93]	2.500 [63.50]	0.750 [19.05]	0.625 [15.88]	0.687 [17.45]	0.160 [0.07]
MS20270B14	7/8"	0.870 [22.10]	3.000 [76.20]	0.937 [23.80]	0.750 [19.05]	0.875 [22.23]	0.220 [0.10]
MS20270B16	1"	0.995 [25.27]	3.375 [85.73]	0.937 [23.80]	0.812 [20.62]	0.875 [22.23]	0.385 [0.17]
MS20270B20	1-1/4"	1.245 [31.62]	3.750 [95.25]	1.000 [25.40]	1.062 [26.97]	0.937 [23.80]	0.630 [0.29]
MS20270B24	1-1/2"	1.495 [37.97]	4.500 [114.30]	1.125 [28.58]	1.250 [21.75]	1.062 [26.97]	1.200 [0.54]

Part No.	Torsional Play			Axial Tension & Compress. (±2%) lbf [N]	Maximum Static Torque (±2%) lbf-in [Nm]	Endurance			
	Test Angle	Test Torque (±2%) lbf-in [Nm]	Limit Degrees (±2%)			Oper. Angle	Torque Load (±2%) lbf-in [Nm]	RPM	Run Time Hours
MS20270B6	0	4 [0.45]	1.00	200 [890]	175 [20]	15	26 [3]	120	2
MS20270B8	0	4 [0.45]	0.80	200 [890]	250 [28]	15	38 [4]	120	2
MS20270B10	0	4 [0.45]	0.64	300 [1334]	500 [56]	15	75 [8]	120	2
MS20270B12	0	4 [0.45]	0.53	400 [1779]	1000 [113]	15	150 [17]	120	2
MS20270B14	0	8 [0.90]	0.46	500 [2224]	1750 [198]	15	262 [30]	120	2
MS20270B16	0	8 [0.90]	0.40	600 [2669]	2500 [282]	15	375 [42]	120	2
MS20270B20	0	8 [0.90]	0.32	800 [3559]	5000 [565]	15	750 [85]	120	2
MS20270B24	0	8 [0.90]	0.27	1100 [4893]	7500 [847]	15	1125 [127]	120	2

Military Standard Joint - MS20271 Heavy Duty Series

- Meets or exceeds military specification MIL-J-6193

Belden's complete universal joint line includes a full range of military certified and continually tested universal joints used in auto racing/gear change linkage, defense vehicles as well as aerospace applications.

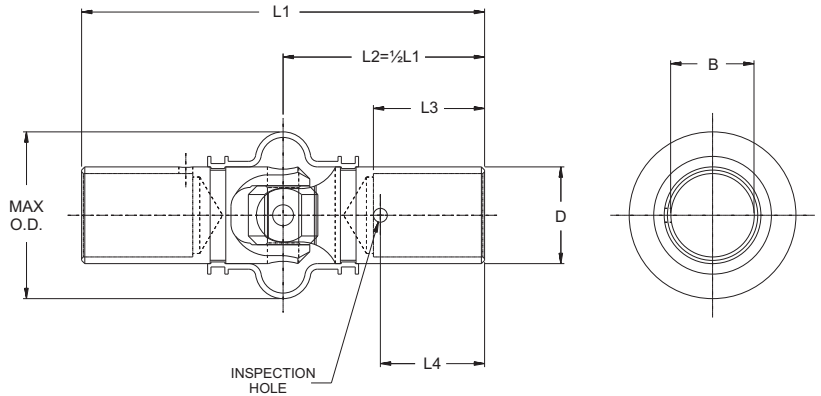

MS20271 Series

Part No.	Nominal Size.	∅ D +0.000 [+0.00] -0.002 [-0.05] in [mm]	L1 Overall Length in [mm]	L3 in [mm]	∅B +0.004 [+0.10] -0.001 [-0.03] in [mm]	L4 Inspection Hole Location in [mm]	Weight Maximum lb [kg]
MS20271B6	3/8"	0.372 [9.45]	2.000 [50.80]	0.500 [12.70]	0.250 [6.35]	0.437 [11.10]	0.070 [0.03]
MS20271B8	1/2"	0.495 [12.57]	2.312 [58.72]	0.625 [15.88]	0.375 [9.53]	0.562 [14.27]	0.090 [0.04]
MS20271B10	5/8"	0.620 [15.75]	2.750 [69.85]	0.750 [19.05]	0.500 [12.70]	0.687 [17.45]	0.180 [0.08]
MS20271B12	3/4"	0.745 [18.93]	3.187 [80.95]	0.875 [22.23]	0.625 [15.88]	0.812 [20.62]	0.240 [0.11]
MS20271B14	7/8"	0.870 [22.10]	3.625 [92.08]	1.000 [25.40]	0.750 [19.05]	0.937 [23.80]	0.350 [0.16]
MS20271B16	1"	0.995 [25.27]	4.062 [103.17]	1.125 [28.58]	0.812 [20.62]	1.062 [26.97]	0.550 [0.25]
MS20271B20	1-1/4"	1.245 [31.62]	4.625 [117.46]	1.187 [30.15]	1.062 [26.97]	1.125 [28.58]	0.900 [0.41]
MS20271B24	1-1/2"	1.495 [37.97]	5.250 [133.35]	1.312 [33.55]	1.250 [21.75]	1.250 [31.75]	1.500 [0.68]

Part No.	Torsional Play			Axial Tension & Compress. (±2%) lbf [N]	Maximum Static Torque (±2%) lbf-in [Nm]	Endurance			
	Test Angle	Test Torque (±2%) lbf-in [Nm]	Limit Degrees (±2%)			Oper. Angle	Torque Load (±2%) lbf-in [Nm]	RPM	Run Time Hours
MS20271B6	0	4 [0.45]	0.83	500 [2224]	200 [23]	15	30 [3]	120	5
MS20271B8	0	4 [0.45]	0.62	1000 [4448]	600 [68]	15	90 [10]	120	5
MS20271B10	0	4 [0.45]	0.50	1500 [6672]	1080 [122]	15	162 [18]	120	5
MS20271B12	0	4 [0.45]	0.42	2000 [8896]	1900 [215]	15	285 [32]	120	5
MS20271B14	0	8 [0.90]	0.36	3500 [15569]	3000 [339]	15	450 [51]	120	5
MS20271B16	0	8 [0.90]	0.32	5000 [22241]	4700 [531]	15	705 [80]	120	5
MS20271B20	0	8 [0.90]	0.24	7000 [31138]	9500 [1073]	15	1425 [161]	120	5
MS20271B24	0	8 [0.90]	0.20	9000 [40034]	14500 [1638]	15	2175 [246]	120	5

Forged Cross + Bearing Joints

- *Handles tough applications*
- *Finished machined hubs*
- *Operates at high RPM*

Belden's extensive line of universal joints include various sizes of Forged Universal Joints commonly sold throughout the automotive market. Other applications typical for this style of universal joint are agriculture steering and linkages, industrial and recreational vehicles and irrigation equipment.

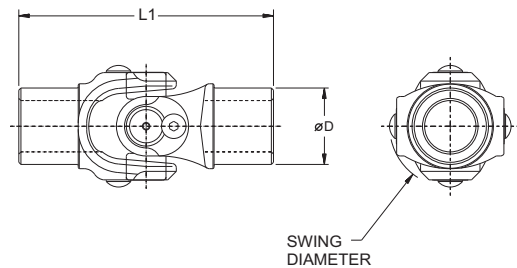
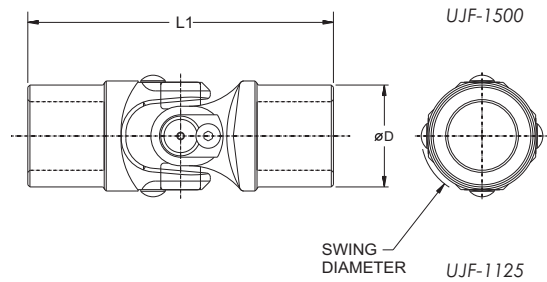

Forged Needle Bearing Joints

Part No.	øD in [mm]	L1 in [mm]	Swing Diameter in [mm]
UJF-1125	1.125 [28.6]	3.75 [95.3]	1.79 [45.5]
UJF-1500	1.500 [38.1]	4.50 [114.3]	1.79 [45.5]

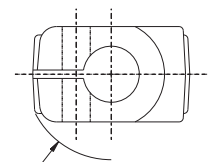
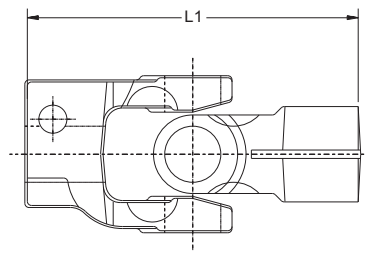
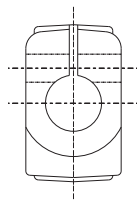

SWING DIAMETER

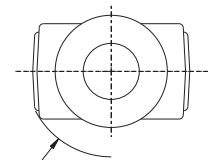
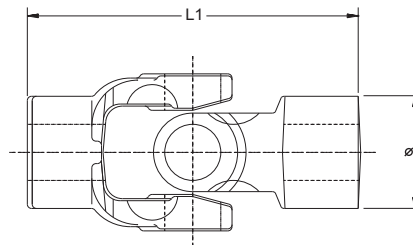
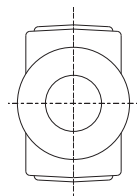

SWING DIAMETER

Medium Duty Forged Universal Joint

Part No.	øD in [mm]	L1 in [mm]	Swing Diameter in [mm]	Max. Bore ø in [mm]
Plain Hub	1.50 [38.1]	3.78 [96.0]	2.40 [61.0]	1.18 [29.97]
Split Hub	1.58 [40.1]	4.50 [114.3]	2.40 [61.0]	1.00 [25.40]

Aluminum Joints + Assemblies

- High strength to weight ratio
- Suited for steering applications
- Finish machined per customer's exact specifications

Belden's Impact Extruded Aluminum universal joint is ideal for applications requiring a high strength to weight ratio. This universal joint was designed in response to the demands made by the light duty vehicle industry where weight reduction is critical. Belden's aluminum universal joints can be found in ATVs (All Terrain Vehicles), electric vehicles and golf carts. Primarily found in steering, Belden's aluminum universal joints can be used in a variety of applications.

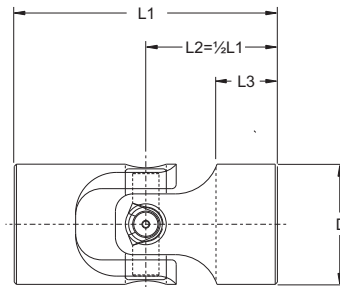

Aluminum Joints with Needle Bearings

Part No.	∅D in [mm]	L1 in [mm]	L2 in [mm]	L3 in [mm]	Ultimate Torque lbf-in [Nm]
UJA-NB1250	1.245 [31.6]	3.75 [95.3]	1.88 [47.6]	1.25 [31.8]	2100 [237.3]
UJA-NB435	1.713 [43.5]	3.78 [96.0]	1.89 [48.0]	0.89 [22.6]	3600 [406.7]

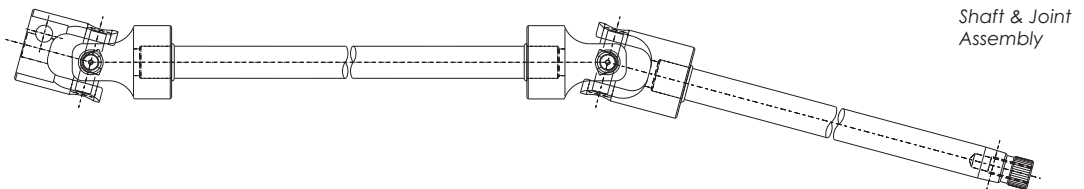

Universal Joint Boot Covers

- Added protection in adverse conditions
- Increases the lifetime of a Universal Joint when filled with Lubricant

If the universal joint assembly is going to operate in an atmosphere that is polluted with chips, dirt, acids and/or other abrasives, it is highly recommended that boots be specified on the original assembly. Boots play an important role in protecting the joint and keeping it fully lubricated. Proper lubrication will prolong the useful life of an assembly by a factor of as much as five.

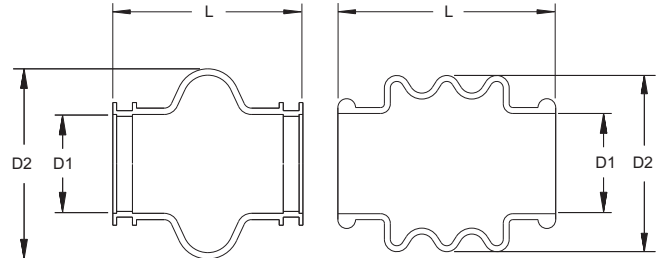

Boot Covers (-LP indicating low profile version)

Part No.	U-Joint nom. OD. in	∅D1 in [mm]	∅D2 in [mm]	L in [mm]	Number of Bellows	Material
375 Boot-CR	3/8	0.38 [9.5]	0.63 [16.0]	0.88 [22.2]	Double	Neoprene
625 Boot-CR	5/8	0.63 [15.9]	1.09 [27.7]	1.03 [26.2]	Single	Neoprene
750 Boot-CR	3/4	0.75 [19.1]	1.38 [35.1]	1.25 [31.8]	Single	Neoprene
500 Boot	1/2	0.50 [12.7]	0.84 [21.3]	0.88 [22.2]	Triple	Nitrile
625 Boot	5/8	0.63 [15.9]	1.09 [27.7]	1.03 [26.2]	Single	Nitrile
750 Boot	3/4	0.75 [19.1]	1.38 [35.1]	1.25 [31.8]	Single	Nitrile
875 Boot	7/8	0.88 [22.2]	1.50 [38.1]	1.50 [38.1]	Single	Nitrile
1000 Boot	1	1.00 [25.4]	1.50 [38.1]	1.88 [47.6]	Single	Nitrile
1125 Boot	1-1/8	1.13 [28.6]	1.75 [44.5]	2.09 [53.2]	Triple	Nitrile
1250 Boot	1-1/4	1.25 [31.8]	1.88 [47.8]	2.09 [53.2]	Triple	Nitrile
1250 Boot-LP	1-1/4	1.25 [31.8]	1.44 [36.6]	2.00 [50.8]	Triple	Nitrile
1500 Boot	1-1/2	1.50 [38.1]	2.25 [57.2]	2.38 [60.3]	Triple	Nitrile
1500 Boot-LP	1-1/2	1.50 [38.1]	1.69 [42.9]	2.63 [66.7]	None	Nitrile
1750 Boot	1-3/4	1.75 [44.5]	2.69 [68.3]	2.88 [73.0]	Triple	Nitrile
1750 Boot-LP	1-3/4	1.75 [44.5]	1.94 [49.3]	3.25 [82.6]	None	Nitrile
2000 Boot	2	1.75 [44.5]	2.69 [68.3]	3.75 [95.3]	Triple	Nitrile
2000 Boot-LP	2	2.00 [50.8]	2.19 [55.6]	4.25 [108.0]	None	Nitrile
2500 Boot	2-1/2	2.50 [63.5]	3.38 [85.9]	4.25 [108.0]	Triple	Nitrile
2500 Boot-LP	2-1/2	2.50 [63.5]	2.69 [68.3]	4.25 [108.0]	None	Nitrile
3000 Boot	3	3.00 [76.2]	4.94 [125.5]	5.63 [142.9]	Triple	Nitrile
3000 Boot-LP	3	3.00 [76.2]	3.25 [82.6]	5.50 [139.7]	None	Nitrile
625 Boot-SL	5/8	0.63 [15.9]	1.09 [27.7]	1.03 [26.2]	Single	Silicone
750 Boot-SL	3/4	0.75 [19.1]	1.38 [35.1]	1.25 [31.8]	Single	Silicone
875 Boot-SL	7/8	0.88 [22.2]	1.50 [38.1]	1.50 [38.1]	Single	Silicone
1000 Boot-SL	1	1.00 [25.4]	1.50 [38.1]	1.88 [47.6]	Triple	Silicone
1250 Boot-SL	1-1/4	1.25 [31.8]	1.88 [47.8]	2.09 [53.2]	Triple	Silicone
625 Boot-VT	5/8	0.63 [15.9]	1.09 [27.7]	1.03 [26.2]	Single	Viton
750 Boot-VT	3/4	0.75 [19.1]	1.38 [35.1]	1.25 [31.8]	Single	Viton
1000 Boot-VT	1	1.00 [25.4]	1.50 [38.1]	1.88 [47.6]	Triple	Viton
1250 Boot-VT	1-1/4	1.25 [31.8]	1.88 [47.8]	2.09 [53.2]	Triple	Viton
625 Boot-EPDM	5/8	0.63 [15.9]	1.09 [27.7]	1.03 [26.2]	Single	EPDM
750 Boot-EPDM	3/4	0.75 [19.1]	1.38 [35.1]	1.25 [31.8]	Single	EPDM
1250 Boot-EPDM	1-1/4	1.25 [31.8]	1.88 [47.8]	2.09 [53.2]	Triple	EPDM

Boot Material Information

Nitrile (standard), also known as **Buna-N**, has excellent resistance to petroleum-based oils and fuels, silicone greases, hydraulic fluids, water and alcohol. It possesses high tensile strength and high abrasion resistance. Silicone boots are recommended for high temperature applications.

Silicone (-SL) is resistant to high, dry heat and is fungus resistant, odorless, tasteless and non-toxic. It has a high resistance to the aging effects of both sunlight and ozone.

Neoprene (-CR) was developed as an oil-resistant substitute for natural rubber. It features moderate resistance to petroleum oils and good resistance to ozone, sunlight, and oxygen aging. It has good resilience and is highly resistant to Freon® and Ammonia.

Viton (-VT) combines high temperature toughness with wide chemical agent compatibility. It features excellent resistance to petroleum products and solvents.

EPDM (-EPDM) has excellent ozone and chemical resistance. Effective resistance to steam up to 400 degrees Fahrenheit, hot water, silicone oils and greases, diluted acids and alkalis, alcohols and automotive break fluids.

Metric Standard Universal Joints

- Metric dimensions following DIN 808
- High-grade alloy steel
- Operating angle up to 45° per joint
- Wide choice of hubs and finishes

The Metric Standard universal joint is manufactured from quality, high-grade alloy steel. The metric single universal joint can operate at angles up to 45°. Metric double universal joints can operate at combined angles up to 90°.

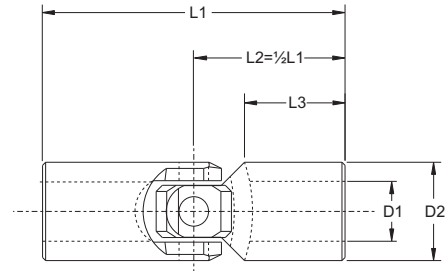

Standard Single Universal Joints

Part No.	∅D2 [mm]	∅D1 H7 [mm]	L1 [mm]	L2 [mm]	L3 [mm]	S H8 [mm]	SW H8 [mm]	K x T [mm]	Max. Op. Torque lbf-in	Max. Op. Torque [Nm]
UJ-HD10	10	5	40	20	13	-	5	-	48	[5.5]
UJ-HD13	13	6	40	20	13	6	-	-	58	[6.6]
UJ-HD16	16	8	40	20	10	8	8	2 x 9	115	[13]
UJ-HD20	20	10	45	22.5	10	10	10	3 x 11.4	204	[23]
UJ-HD25	25	12	50	25	11	12	12	4 x 13.8	354	[40]
UJ-HD29	29	14	56	28	13	14	14	5 x 16.3	531	[60]
UJ-HD32	32	16	65	32.5	15	16	16	5 x 18.3	708	[80]
UJ-HD37	37	18	72	36	17	18	18	6 x 20.8	1328	[150]
UJ-HD40	40	20	82	41	19	20	20	6 x 22.8	1770	[200]
UJ-HD47	47	22	95	47.5	22	22	22	6 x 24.8	2478	[280]
UJ-HD50	50	25	108	54	27	25	25	8 x 28.3	3098	[350]
UJ-HD58	58	30	122	61	30	30	30	8 x 33.3	3540	[400]

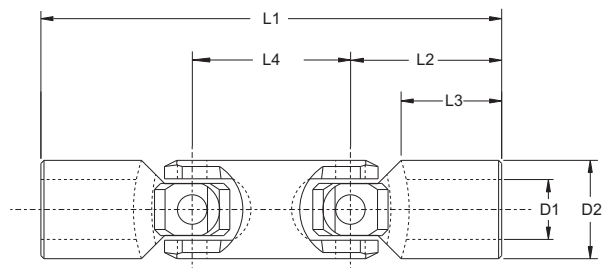

Standard Double Universal Joints

Part No.	∅D2 [mm]	∅D1 H7 [mm]	L1 [mm]	L2 [mm]	L3 [mm]	L4 [mm]	S H8 [mm]	SW H8 [mm]	K x T [mm]	Max. Operating Torque lbf-in	Max. Operating Torque [Nm]
DUJ-HD13	13	6	63	20	13	23	6	-	-	53	[6]
DUJ-HD16	16	8	67	20	10	27	8	8	2 x 9	104	[12]
DUJ-HD20	20	10	74	22.5	10	29	10	10	3 x 11.4	183	[21]
DUJ-HD22	22	12	74	25	11	29	12	12	4 x 13.8	319	[36]
DUJ-HD25	25	14	85	28	13	33	14	14	5 x 16.3	478	[54]
DUJ-HD29	29	16	100	32.5	19	35	16	16	5 x 18.3	637	[72]
DUJ-HD32	32	18	112	36	20	39	18	18	6 x 20.8	1195	[135]
DUJ-HD40	40	20	128	41	19	46	20	20	6 x 22.8	1593	[180]
DUJ-HD40	40	22	145	47.5	25	46	22	22	6 x 24.8	2230	[252]
DUJ-HD50	50	25	163	54	24	59	25	25	8 x 28.3	2788	[315]
DUJ-HD58	58	30	182	61	30	66	30	30	8 x 33.3	3186	[360]

Metric Precision Universal Joints

- Metric dimensions following DIN 808
- Hardened bushings
- Operating angle up to 45° per joint

The metric high strength (precision) universal joints are pin and block style and are equipped with hardened bushings for increased endurance and reliable performance.

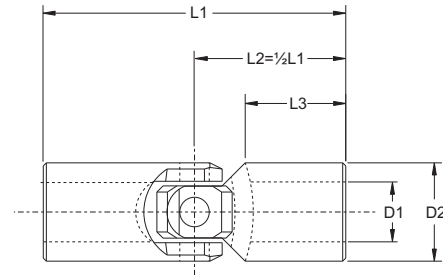

Precision Single Universal Joints

Part No.	∅D2 [mm]	∅D1 H7 [mm]	L1 [mm]	L2 [mm]	L3 [mm]	S H8 [mm]	SW H8 [mm]	K x T [mm]	Max. Op. Torque lbf-in [Nm]
UJ-HS16	16	8	40	20	11	-	-	2 x 9	115 [13]
UJ-HS20	20	10	45	22.5	10	10	10	3 x 11.4	221 [25]
UJ-HS22	22	10	45	22.5	10	10	10	3 x 11.4	221 [25]
UJ-HS25	25	12	50	25	11	12	12	4 x 13.8	380 [43]
UJ-HS29	29	14	56	28	13	14	14	5 x 16.3	601 [68]
UJ-HS32	32	16	65	32.5	15	16	16	5 x 18.3	761 [86]
UJ-HS37	37	18	72	36	17	18	18	6 x 20.8	1380 [156]
UJ-HS40	40	20	82	41	19	20	20	6 x 22.8	2124 [240]
UJ-HS47	47	22	95	47.5	22	22	22	6 x 24.8	2655 [300]
UJ-HS50	50	25	108	54	26	25	25	8 x 28.3	3398 [384]
UJ-HS58	58	30	122	61	30	30	30	8 x 33.3	3823 [432]
UJ-HS63	63	32	130	65	30	30	35	10 x 35.3	3823 [432]
UJ-HS70	70	35	140	70	35	-	35	10 x 38.3	4035 [456]
UJ-HS80	80	40	160	80	42	-	35	12 x 43.3	4460 [504]
UJ-HS95	93	50	190	85	54	-	35	14 x 53.8	6372 [720]

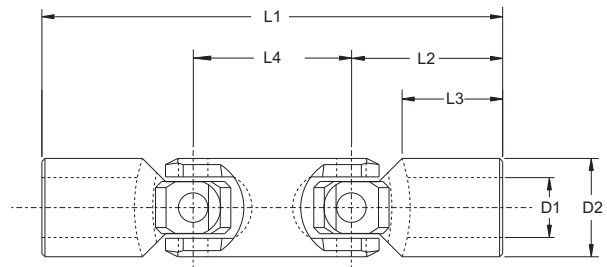

Precision Double Universal Joints

Part No.	∅D2 [mm]	∅D1 H7 [mm]	L1 [mm]	L2 [mm]	L3 [mm]	L4 [mm]	S H8 [mm]	SW H8 [mm]	K x T [mm]	Max. Op. Torque lbf-in [Nm]
DUJ-HS16	16	8	67	20	9	27	-	-	2 x 9	106 [12]
DUJ-HS20	20	10	75	22.5	10	30	10	10	3 x 11.4	203 [23]
DUJ-HS22	22	12	74	22.5	11	29	12	12	4 x 13.8	203 [23]
DUJ-HS25	25	14	85	26	13	33	14	14	5 x 16.3	345 [39]
DUJ-HS29	29	16	100	28	19	35	16	16	5 x 18.3	539 [61]
DUJ-HS32	32	18	112	32.5	20	39	18	18	6 x 20.8	681 [77]
DUJ-HS40	40	20	128	41	19	46	20	20	6 x 22.8	1911 [216]
DUJ-HS50	50	25	163	54	24	59	25	25	8 x 28.3	3062 [346]
DUJ-HS58	58	30	182	61	28	66	30	30	8 x 33.3	3442 [389]
DUJ-HS63	63	32	198	65	30	84	30	35	10 x 35.3	3442 [389]
DUJ-HS70	70	35	212	70	32	78	-	35	10 x 38.3	3628 [410]
DUJ-HS80	80	40	245	80	38	95	-	35	12 x 43.3	4018 [454]
DUJ-HS95	93	50	290	85	50	120	-	35	14 x 53.8	5735 [648]

Metric Stainless Steel Universal Joints

- Metric dimensions following DIN 808
- Yoke material DIN 1.4305 (AISI 303)
- Wide choice of hubs and finishes
- Operating angle up to 45° per joint

The metric stainless steel universal joint is made of AISI 303 [DIN 1.4305] stainless steel and is equipped with friction bearings. Metric stainless steel universal joints can operate at angles up to 45°. The double metric stainless steel joint operates at combined angles up to 90°.

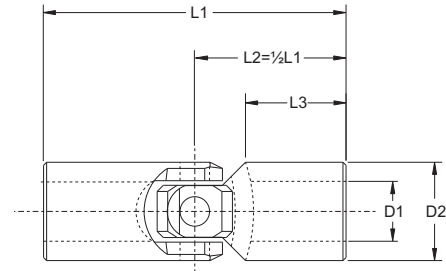

Stainless Steel Single Universal Joints

Part No.	∅D2 [mm]	∅D1 H7 [mm]	L1 [mm]	L2 [mm]	L3 [mm]	S H8 [mm]	SW H8 [mm]	K x T [mm]	Max. Op. Torque lbf-in [Nm]
UJ-SS10	10	5	44	22	15	-	5	-	32 [3.6]
UJ-SS13	13	6	50	25	18	6	-	-	39 [4.4]
UJ-SS16	16	8	58	28	19	8	8	2 x 9	76 [8.6]
UJ-SS22	22	10	76	38	25	10	10	3 x 11.4	109 [12.3]
UJ-SS25	25	12	86	43	29	12	12	4 x 13.8	186 [21]
UJ-SS29	29	14	90	45	30	14	14	5 x 16.3	292 [33]
UJ-SS32	32	16	95	47.5	30	16	16	5 x 18.3	398 [45]
UJ-SS37	37	18	108	54	35	18	18	6 x 20.8	673 [76]
UJ-SS40	40	20	108	54	32	20	20	6 x 22.8	1036 [117]
UJ-SS47	47	22	127	63.5	38	22	22	6 x 24.8	1292 [146]
UJ-SS50	50	25	140	70	44	25	25	8 x 28.3	1699 [192]
UJ-SS58	58	30	178	89	58	30	30	8 x 33.3	1912 [216]

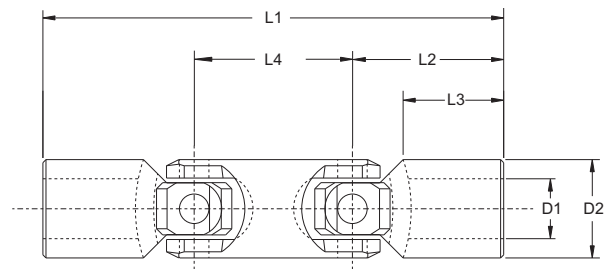

Stainless Steel Double Universal Joints

Part No.	∅D2 [mm]	∅D1 H7 [mm]	L1 [mm]	L2 [mm]	L3 [mm]	L4 [mm]	S H8 [mm]	SW H8 [mm]	K x T [mm]	Max. Op. Torque lbf-in [Nm]
DUJ-SS22	22	12	105	38	25	29	12	12	4 x 13.8	97 [11]
DUJ-SS25	25	14	119	43	29	33	14	14	5 x 16.3	168 [19]
DUJ-SS29	29	16	125	45	30	35	16	16	5 x 18.3	266 [30]
DUJ-SS32	32	18	134	47.5	30	39	18	18	6 x 20.8	363 [41]
DUJ-SS40	40	20	154	54	32	46	20	20	6 x 22.8	929 [105]
DUJ-SS50	50	25	199	70	44	59	25	25	8 x 28.3	1531 [173]
DUJ-SS58	58	30	244	89	58	66	30	30	8 x 33.3	1717 [194]

Metric Needle Bearing Universal Joints

- Needle Bearings for operation up to 4000 RPM
- Operating angle up to 45° per joint

The metric needle bearing universal joint is made from high-grade alloy steel. It is equipped with needle roller bearings that allow operation at speeds up to 4000 RPM. The needle bearing universal joint is available in a wide variety of hub configurations and finishes.

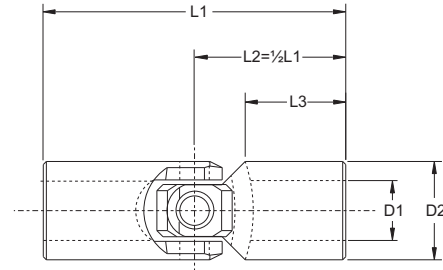

Needle Bearing Single Universal Joints

Part No.	∅D2 [mm]	∅D1 H7 [mm]	L1 [mm]	L2 [mm]	L3 [mm]	S H8 [mm]	SW H8 [mm]	K x T [mm]	Max. Op. Torque lbf-in	[Nm]
UJ-NB16	16	8	52	26	15	8	8	2 x 9	97	[11]
UJ-NB20	20	10	62	31	18	10	10	3 x 11.4	195	[22]
UJ-NB25	25	14	74	37	20	12	12	5 x 16.3	301	[34]
UJ-NB32	32	16	86	43	24	16	16	5 x 18.3	575	[65]
UJ-NB37	37	18	72	36	17	18	18	6 x 20.8	664	[75]
UJ-NB40	40	20	108	54	30	20	20	6 x 22.8	1239	[140]
UJ-NB47	47	22	95	47.5	22	22	22	6 x 24.8	1434	[162]
UJ-NB50	50	25	132	66	38	25	25	8 x 28.3	1770	[200]
UJ-NB63	63	30	166	83	45	30	30	8 x 33.3	2655	[300]
UJ-NB63	63	32	166	83	45	-	-	8 x 35.3	2655	[300]
UJ-NB70	70	35	140	70	35	-	35	10 x 38.3	2885	[326]
UJ-NB80	80	40	180	90	50	-	35	12 x 43.3	3231	[365]
UJ-NB95	95	50	190	95	54	-	35	14 x 53.8	3558	[402]

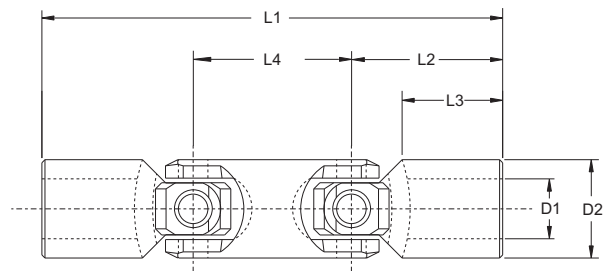

Needle Bearing Double Universal Joints

Part No.	∅D2 [mm]	∅D1 H7 [mm]	L1 [mm]	L2 [mm]	L3 [mm]	L4 [mm]	S H8 [mm]	SW H8 [mm]	K x T [mm]	Max. Op. Torque lbf-in	[Nm]
DUJ-NB20	20	10	88	44	18	26	10	10	3 x 11.4	177	[20]
DUJ-NB25	25	14	104	52	19	33	14	14	5 x 16.3	266	[30]
DUJ-NB32	32	16	125	62.5	24	39	16	16	5 x 18.3	513	[58]
DUJ-NB40	40	20	156	78	30	48	20	20	6 x 22.8	1115	[126]
DUJ-NB50	50	25	188	94	37	59	25	25	8 x 28.3	1593	[180]
DUJ-NB63	63	30	238	119	41	80	30	30	8 x 33.3	2390	[270]
DUJ-NB63	63	32	238	119	41	80	-	-	8 x 35.3	2390	[270]
DUJ-NB70	70	35	212	106	30	78	-	35	10 x 38.3	2593	[293]
DUJ-NB80	80	40	290	145	48	120	-	35	12 x 43.3	2903	[328]
DUJ-NB95	95	50	290	145	50	120	-	35	14 x 53.8	3195	[361]

Quick Release Ends

- Quick and easy connection
- Available for all metric styles
- For keyway and hexagonal bores

The Quick Release feature is a special end configuration to allow rapid and easy connection and release of metric universal joints. All Belden metric universal joints can be fitted with the quick release end feature.

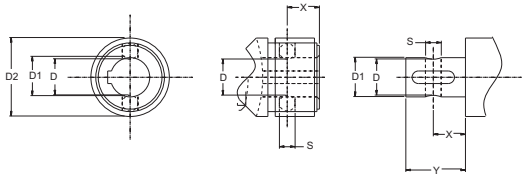

Quick release detail for bores with keyway

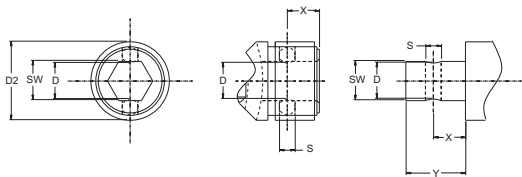

Quick release detail for hexagonal bores



Quick Release End Details

∅ D2 Joint OD [mm]	∅ D1 [mm]	SW H8 [mm]	∅ D [mm]	Y [mm]	X [mm]	∅ S [mm]
20	10	10	8.7	18	11.5	4
22	10	10	8.7	17	11.5	4
25	12 (14)	12	11 (13)	21	13.5	4
29	14	14	13	21	13.5	4
32	16	16	14.8	25	14	6.3
37	18	18	16	33	19	8
40	20	20	18	33	19	8
47	22	22	20	38	20.5	10
50	25	25	23	38	20.5	10
58	30	30	28	50	25	10
63	30	30	28	50	25	10

Metric Custom Drive Shafts & Custom Universal Joints

- Custom designed to meet customer specifications
- Quick-change feature available

Belden's metric drive shafts can be developed from the metric universal joint to fit a wide range of applications. The overall length can be designed to the customer's exact specification. Custom drive shaft assemblies can be telescoping and spring loaded with a variety of hub end configurations to choose from.

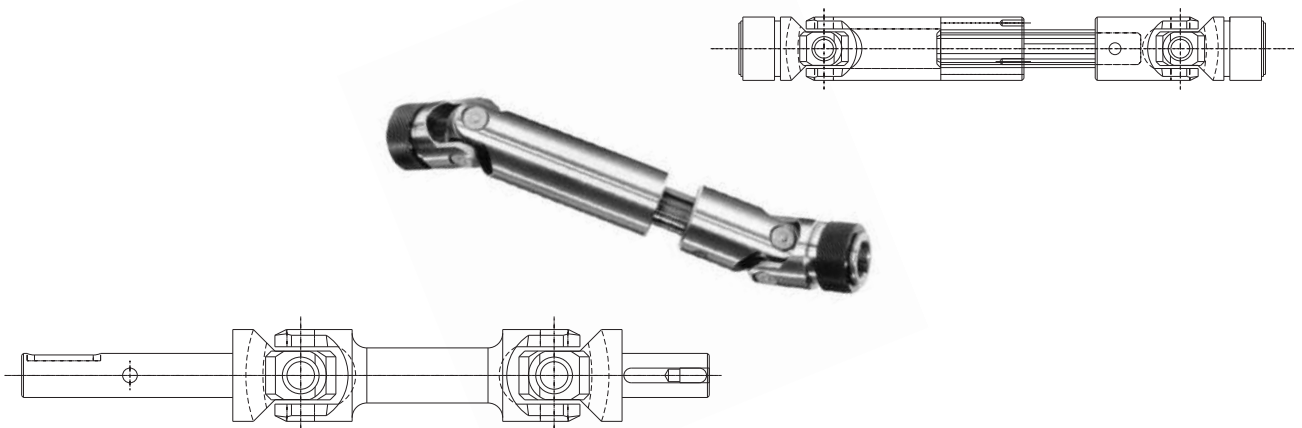

Metric Universal Joint Boot Covers

- Increased protection in abrasive and corrosive environments
- Available for all metric joints

Belden's metric universal joint boot covers provide additional protection for the pins & block. The center components can maintain lubrication and are covered from dirt and debris.

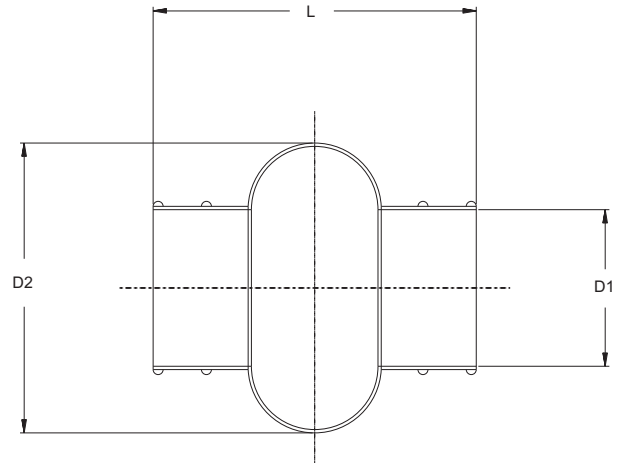

Universal Joints Boot Covers

Part No.	Joint OD [mm]	øD2 [mm]	øD1 [mm]	L [mm]
BOOT20	20	39	20.5	47
BOOT25	25	47	24.5	52
BOOT29	29	51	27.5	58
BOOT32	32	56	30.5	67
BOOT37	37	66	35.5	74
BOOT40	40	75	40	84
BOOT47	47	83	45	97
BOOT50	50	93	50	110
BOOT58	58	105	56	124

The standard material for Metric Boots is Neoprene. Additional sizes and materials available upon request.

Universal Joint Request for Quotation

<p>BORE SIZE AND CONFIGURATION LEFT END</p> <p>MALE <input type="checkbox"/> FEMALE <input type="checkbox"/></p> <p><input type="checkbox"/> PLAIN</p> <p><input type="checkbox"/> KEYWAY</p> <p><input type="checkbox"/> HEXAGONAL</p> <p><input type="checkbox"/> SQUARE</p> <p><input type="checkbox"/> THREADED</p> <p><input type="checkbox"/> SPLINE</p>	<p><i>DOUBLE UNIVERSAL JOINT (TELESCOPING VERSION SHOWN)</i></p> <p><i>SINGLE UNIVERSAL JOINT</i></p> <p>BOOTS SHOWN FOR REFERENCE, BUT ARE OPTIONAL.</p>	<p>BORE SIZE AND CONFIGURATION RIGHT END</p> <p>MALE <input type="checkbox"/> FEMALE <input type="checkbox"/></p> <p><input type="checkbox"/> PLAIN</p> <p><input type="checkbox"/> KEYWAY</p> <p><input type="checkbox"/> HEXAGONAL</p> <p><input type="checkbox"/> SQUARE</p> <p><input type="checkbox"/> THREADED</p> <p><input type="checkbox"/> SPLINE</p>
---	---	--

Joint to be used for:			
Nature of operation:	Continuous: <input type="checkbox"/>	Intermittent: <input type="checkbox"/>	
Operating temperature:	Maximum:	Minimum:	Average:
Operating environment:	Abrasive: <input type="checkbox"/>	Corrosive: <input type="checkbox"/>	Clean: <input type="checkbox"/> Other:
Actual horsepower:	Torque:	RPM:	
Angle of operation:	Maximum:	Minimum:	Average:
Center connection:	Axially free: <input type="checkbox"/>	Axially free w. retaining ring: <input type="checkbox"/>	W. spring + retaining ring: <input type="checkbox"/>
Boots:	Booted: <input type="checkbox"/>	Unbooted: <input type="checkbox"/>	
Material:	Alloy: <input type="checkbox"/>	Stainless: <input type="checkbox"/>	Other:
Finish:	Cadmium: <input type="checkbox"/>	Nickel: <input type="checkbox"/>	Zinc: <input type="checkbox"/> Black Oxide: <input type="checkbox"/> Other:
Quantity:			
Name:		Company:	
Address:			
City:		Postal code:	Country:
Telephone:		Fax:	
E-mail:			

Please copy and fax to your Belden contact. (For details see contact info at the end of the catalog)

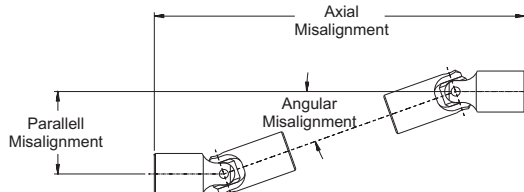
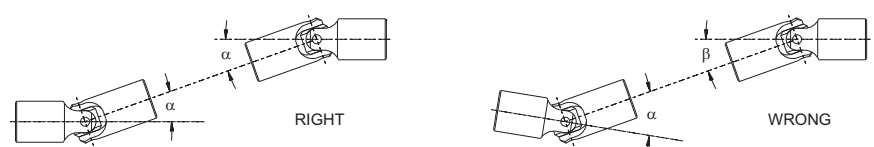
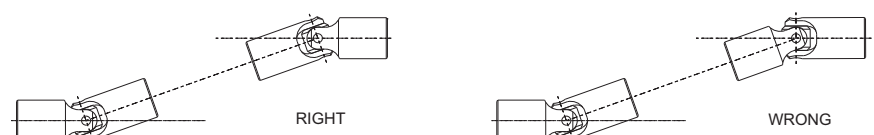
<p>Universal Joint</p>	<p>A mechanical device that can transmit torque and/or rotary motion from one shaft to another at fixed or varying angles of intersection of the shaft's axis.</p>
<p>Pin and Block Universal Joint</p>	<p>Also know as the Cardan or Hooke joint, the pin and block is the simplest unit available. It allows for a more positive transmission of rotating power or torque than conventional flexible couplings.</p>
<p>Cross and Bearing Universal Joint</p>	<p>A forged cross with a needle bearing connection provides minimal backlash and precise positioning without compromising torque capacity.</p>
<p>Needle Bearing Universal Joint</p>	<p>Needle bearings are installed at the pin ends to reduce backlash and increase precision and RPM capability.</p>
<p>Torque</p>	<p>Torque is the force that causes rotation. Operating torque is the amount of torque that is transmitted during normal operation. Torque is commonly expressed in pound inches (lbf-in), pound-feet (lbf-ft), or Newton-meters (Nm). $T [lbf-in] = \frac{Power [HP] \times 63024}{RPM}$ $T [Nm] = \frac{Power [kW] \times 9550}{RPM}$</p>
<p>Axial, Parallel & Angular Misalignment</p>	<p>Axial misalignment is the amount of axial movement (end play) between the shafts, which is typically caused by motor vibration. Parallel misalignment is the offset between driving and driven shaft. Angular misalignment is the angle at which the shafts intersect.</p> 
<p>Torsional Stiffness</p>	<p>Torsional stiffness is the degree of resistance against twist. It is commonly expressed in pound-inch/radian (lbf-in/rad) or Newton-meter/radian (Nm/rad). 6.47357 Pound Inch/Radian (lbf-in/rad) = 1 Newton-meter/Radian (Nm/rad). 0.01745 Pound Inch/Degree (lbf-in/Grad) = 1 Pound Inch/Radian (lbf-in/rad).</p>
<p>Zero Backlash</p>	<p>Zero backlash refers to the amount of radial play within a coupling assembly.</p>
<p>Duty Cycle</p>	<p>The load on a universal joint is either intermittent or continuous. Under most operating conditions, a joint's intermittent load capacity is greater than its continuous load capacity.</p>
<p>Unit Conversion</p>	<p> $1 \text{ lbf-in} = 0.11299 \text{ Nm}$ $1 \text{ lbf-ft} = 1.35582 \text{ Nm}$ $1 \text{ Nm} = 8.85075 \text{ lbf-in}$ $1 \text{ Nm} = 0.73756 \text{ lbf-ft}$ $1 \text{ HP} = 0.7457 \text{ kW}$ $1 \text{ kW} = 1.341 \text{ HP}$ $1 \text{ Inch} = 25.4 \text{ mm}$ $1 \text{ mm} = 0.0394 \text{ Inch}$ $1 \text{ lbf} = 0.4536 \text{ kg}$ $1 \text{ kg} = 2.2046 \text{ lbf}$ </p>
<p>Constant Velocity</p>	<p>In order to achieve constant velocity operation, driving & driven shaft are required to be aligned parallel.</p> 
<p>Yoke Orientation</p>	<p>When creating a double joint by connecting two single joints with a shaft, the yokes of the inbound joints are required to be aligned as shown below.</p> 

Contact us:



Belden Tools, Inc.
2500 Braga Drive
Broadview, Illinois 60155
USA
Tel: +1 708 344-4600
Fax: +1 708 344-0245
info@beldenuniversal.com



PTMotion GmbH
Geneststr. 5
10829 Berlin
Germany
Tel: +49 30 72 14 143
Fax: +49 30 72 14 142
info@ptmotion.de

www.BeldenUniversal.com